

VistaScan Ultra View

EN



Installation and Operating Instructions

CE
UK
CA

2170100001L29



 **DÜRR
DENTAL**

2411V008

Contents



Important information

1 About this document	3
1.1 Warnings and symbols	3
1.2 Copyright information	5
2 Safety	6
2.1 Intended purpose	6
2.2 Intended use	6
2.3 Improper use	6
2.4 General safety information	6
2.5 Specialist personnel	6
2.6 Electrical safety	6
2.7 Essential performance characteristics	7
2.8 Notification requirement for serious incidents	7
2.9 Only use original parts	7
2.10 Transport	7
2.11 Disposal	7
2.12 Using image plates and light protection covers	8
2.13 Using software	8
2.14 Protection from threats from the Internet	8



Product description

3 Overview	9
3.1 Scope of delivery	10
3.2 Accessories	10
3.3 Consumables	10
3.4 Wear parts & replacement parts	10
3.5 Optional articles	11
4 Technical data	12
4.1 Image plate scanner	12
4.2 Image plate	16
4.3 Light protection cover	16
4.4 Type plate	17
4.5 Evaluation of conformity	17

5 Operation	17
5.1 Image plate scanner	17
5.2 Image plate	18
5.3 Light protection cover	19
5.4 Protection cover	19
5.5 Storage box	19
5.6 Bite protector (optional)	19



Assembly

6 Requirements	20
6.1 Installation/setup room	20
6.2 Counter top/table set-up	20
6.3 Monitor	20
6.4 Computer system requirements	20
7 Installation	21
7.1 Carrying the unit	21
7.2 Setting up the unit	21
7.3 Removing the protective film	21
7.4 Checking the memory card	21
7.5 Software installation	22
7.6 Electrical connections	22
7.7 Connecting the device to the network	22
8 Commissioning	24
8.1 Configuring the network	24
8.2 Configuring WLAN on the unit	24
8.3 Configuring the unit	24
8.4 X-ray unit settings	26
8.5 Acceptance tests	28



Usage

9 Operating the touch screen	29
9.1 Navigating	29
9.2 Using menus	29
9.3 Entering text in the field	29
9.4 Calling up messages on the screen	30
9.5 System settings	30
9.6 Main menu	31
10 Correct use of image plates and light protection covers	33

11 Operation	34
11.1 Changing the plate guide.	34
11.2 X-ray.	34
11.3 Scanning the image data via a computer	36
11.4 Scanning image data via the touch screen on the unit	37
11.5 Erasing the image plate.	39
11.6 Switch off the unit.	39
12 Cleaning and disinfection	40
12.1 Image plate scanner	40
12.2 Light protection cover	40
12.3 Image plate.	40
12.4 Plate guides	40
12.5 Storage box with image plate storage tray	41
13 Maintenance	41
13.1 Yearly scheduled maintenance . . .	41
13.2 Recommended maintenance schedule.	42



Troubleshooting

14 Tips for operators and service technicians	43
14.1 Poor X-ray image	43
14.2 Software error.	46
14.3 Fault on the unit.	48
14.4 Error messages on the touch screen.	49



Appendix

15 Scanning times	51
16 File size (uncompressed)	51
17 Electromagnetic Compatibility (EMC) Compliance Information	52
18 Manufacturer's Guidance and Decla- ration - Electromagnetic Emissions . . .	52
19 Recommended separation distances between equipment	55
20 Handover record	56



Important information

1 About this document

This Installation and Operating Instructions manual provides the information necessary for the set-up, operation and routine care and maintenance of the VistaScan Ultra View Image Plate Scanner. The manual forms an integral part of the device and conforms to the relevant version of the equipment and the technical standards valid at the time of installation. This manual, along with the quick start guide, should be thoroughly reviewed by dental professionals prior to scanning and processing digital images exposed on imaging plates. No re-training is necessary in the dental clinic unless there is new personnel. The English version of this manual is the original manual, which is used to translate all other languages. These Instructions are valid for VistaScan Ultra View, part number 2170100500. The term light protection cover and image plate is, for reasons of simplified readability, used as a collective term for parts listed in section 3.2, 3.3 and 3.4.

 If the instructions and information in this document are not followed, Dürr Dental will not be able to offer any warranty or assume any liability for the safe operation and functioning of the unit.

1.1 Warnings and symbols

Warnings

The warnings in this document are intended to draw your attention to possible injury to persons or damage to machinery.

The following warning symbols are used:

 General warning symbol

 Warning – dangerous high voltage

The warnings are structured as follows:

 **Signal word**
Description of type and source
 Here you will find the possible consequences of ignoring the warning
 > Follow measures to avoid the danger.

The signal word differentiates between four levels of danger:

- **DANGER**
Immediate danger of severe injury or death
- **WARNING**
Possible danger of severe injury or death
- **CAUTION**
Risk of minor injuries
- **NOTICE**
Risk of extensive material/property damage

Other symbols

These symbols are used in the document and on or in the unit:



Note, e.g. specific instructions regarding efficient and cost-effective use of the unit



Order number



Serial number



Medical device



Model number



Lot designation



Indicates IEC 60601-1 Class II, double insulated equipment



CE labelling



CE labelling with the number of the notified body



Manufacturer



Conformity mark for the United Kingdom of Great Britain and Northern Ireland



Dispose of correctly in accordance with EU Directive 2012/19/EU (WEEE).



Refer to the accompanying electronic documents.



Please read all of the accompanying documents.



Refer to Operating Instructions.



Wear protective gloves.



Disconnect all power from the unit.





Do not reuse



Warning - laser beam

 DC current

 Known-ionizing electromagnetic radiation

 This way up / store and transport in an upright position

 Keep dry

 Stacking limits

 Lower and upper humidity limits

 Lower and upper temperature limits

 Lower and upper atmospheric pressure limits

 Fragile, handle with care

 Keep away from sunlight

 Unique Device Identifier

 Distributor



ELECTRIC SHOCK RISK

- › The power line cord is the main power disconnect.
- › Use only the line cord provided with the unit.
- › To avoid risk of electric shock, fire, short-circuit or dangerous emissions, never insert any metallic object into the equipment.
- › Only use connection cable(s) delivered with the device.
- › Check the device cables for possible damage before switching on. Damaged cables, plugs and sockets must be replaced before use.
- › Only use the Mega Electronics power supply MDM065T-A240 provided with the unit as it is a critical part of the ME EQUIPMENT.



CAUTION

- › While the VistaScan Ultra View has been designed to minimise exposure of personnel to hazards, any use of the device that is not compliant with the instructions specified in this manual may result in permanent failure of the unit or unsafe operation.
- › Only trained professionals should use this device. Use of this device, other than as described in this manual, may result in injury.
- › Before every use, the operator must check the functional safety and the condition of the device. The operator must be knowledgeable in the operation of the device.
- › Operate VistaScan Ultra View in a dry environment. To prevent injury from fire or electrical shock, do not expose this appliance to rain or moisture.
- › Use of controls or adjustments or performance of procedures other than those specified herein may result in hazardous radiation exposure
- › The use of ACCESSORY equipment that does not comply with the equivalent safety requirements of this equipment may lead to a reduced level of safety of the resulting system.
- › Use of ACCESSORIES or cables other than those specified or provided by the manufacturer may result in increased EMISSIONS or decreased IMMUNITY of the EQUIPMENT.

Knowledge of warnings and cautions.

Users must exercise every precaution to ensure personnel safety, and be familiar with the warnings and cautions presented throughout this manual and summarised below.

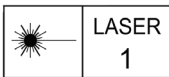

- › VistaScan Ultra View contains a laser and is a Class 1 (IEC 60825) Laser Product. Use of controls or adjustments or performance of procedures other than those specified herein may result in hazardous radiation exposure. The laser is on only during an active scan.
- › Alerts user that VistaScan Ultra View becomes a Class 3B device when opened. Only a trained technician from an authorised dealer should remove a cover from the VistaScan Ultra View. Direct eye contact with the output beam from the laser may cause serious damage and possible blindness.

- › Portable RF communications equipment (including peripherals such as antenna cables and external antennas) should be used no closer than 30 cm to any part of the VistaScan Ultra View, including cables specified by the manufacturer. Otherwise, degradation of the performance of this equipment could result.



NOTICE

- › Do not use damaged image plates. Damaged image plates may not provide reliable diagnostic images.
- › Laser product compliance: VistaScan Ultra View meets the requirements of IEC 60825-1 Ed. 3 (2014).
- › EMC Compliance Requirements:
 - › The unit is intended for use in professional healthcare facilities (in accordance with IEC 60601-1-2). If the appliance is operated in another environment, potential effects on electromagnetic compatibility must be taken into account.
 - › Do not operate the unit in the vicinity of HF surgical instruments or MRT equipment.
 - › Maintain a minimum distance of at least 30 cm between the unit and other electronic devices.
 - › Keep a minimum distance of 30 cm between the unit and mobile radio devices.
 - › Stacking or using the scanner adjacent to other equipment may violate EMC compliance and interfere with the scanner operation.
 - › The device transmits and receives RF at 13.56 MHz.
 - › Operate the scanner outside of the patient environment, at least 1.5 m away from the patient. Do not touch the device and the patient simultaneously.
 - › Image plate preparation: Completely clean and erase image plates before taking an X-ray exposure. See the image plate preparation section of this manual.

- › Use care when handling image plates: Avoid fingerprints and scratching. Refer to the instructions provided with the image plate package for further information on handling.
- › Equipment disposal. Disposal of VistaScan Ultra View, including internal electronic circuitry and image plates must be carried out only at the appropriate facilities for recovery and recycling. Make sure that such items are disposed of in accordance with current federal, national, state and local government rules and regulations.
- › Keep device dry. Do not spray solvents or liquid directly on the scanner.
- › Insert image plate only. Avoid damage to the VistaScan Ultra View transport by making sure that the light protection cover does not get pulled into the transport along with the image plate.
- › The equipment EMISSIONS characteristics make it suitable for use in industrial areas and hospitals (CISPR 11 class A). If it is used in a residential environment (for which CISPR class B is normally required) this equipment might not offer adequate protection to radio frequency communication services. The user might need to take mitigation measures, such as relocating or re-orienting the equipment.

1.2 Copyright information

All circuits, processes, names, software programs and units mentioned in this document are protected by copyright.

The Installation and Operating Instructions must not be copied or reprinted, neither in full nor in part, without written authorization from Dürr Dental.

2 Safety

The VistaScan Ultra View has been designed and constructed so that, when used properly and for the intended purpose, it does not pose any danger to people or property. Nevertheless, residual risks can remain. You should therefore observe the following notes.

2.1 Intended purpose

VistaScan Ultra View

The unit is intended exclusively for use in dental applications for the scanning and processing of image data on an image plate.

VistaScan Light Protection Cover

The functions of the light protection cover are:

- to protect the image plate from light and therefore against accidental erasure
- to protect against cross contamination

2.2 Intended use

VistaScan Ultra View

The unit may only be operated using accessories and optional articles manufactured by or branded with Dürr Dental.

The unit may only be cleaned using the disinfectants and cleaning agents approved by and specified by the manufacturer.

VistaScan Light Protection Cover

The light protection cover is a disposable item. The light protection cover is designed exclusively for use with image plate scanners manufactured by or branded with Dürr Dental and image plates manufactured by or branded with Dürr Dental.

2.3 Improper use

VistaScan Ultra View

Any other usage or usage beyond this scope is deemed to be improper. The manufacturer accepts no liability for damages resulting from improper usage. The user bears the sole risk. This unit is not suitable for monitoring patients over longer periods of time. This unit must not be operated in operating theaters or similar rooms, in which dangers may arise from the combustion of flammable materials.

VistaScan Light Protection Cover

Any other usage or usage beyond this scope is deemed to be improper. The manufacturer accepts no liability for damages resulting from improper usage. The user bears the sole risk. Especially: The multiple use of this accessory and reprocessing contrary to instructions of the manufacturer.

The use of the accessory in combination with other than image plate scanners manufactured by or branded with Dürr Dental and image plates manufactured by or branded with Dürr Dental.

2.4 General safety information

- › Always comply with the specifications of all guidelines, laws, and other rules and regulations applicable at the site of operation for the operation of this unit.
- › Check the function and condition of the unit prior to every use.
- › Do not convert or modify the unit.
- › Comply with the specifications of the Installation and Operating Instructions.
- › The Installation and Operating Instructions must be accessible to all operators of the unit at all times.

2.5 Specialist personnel

Operation

Operating personnel must ensure safe and correct handling based on their training and knowledge.

- › Have every user instructed in handling the unit.

Installation and repairs

- › Installation, readjustments, alterations, upgrades and repairs must be carried out by Dürr Dental or by qualified personnel specifically approved and authorised by Dürr Dental.

2.6 Electrical safety

- › Comply with all the relevant electrical safety regulations when working on the unit.
- › Never touch the patient and unshielded plug connections or metallic parts of the device at the same time.
- › Replace damaged cables or plugs immediately.

Observe the EMC rules concerning medical devices

- › The unit is intended for use in professional healthcare facilities (in accordance with IEC 60601-1-2). If the appliance is operated in another environment, potential effects on electromagnetic compatibility must be taken into account.
- › Do not operate the unit in the vicinity of HF surgical instruments or MRT equipment.
- › Maintain a minimum distance of at least 30 cm between the unit and other electronic devices.
- › Keep a minimum distance of 30 cm between the unit and mobile radio devices.

- › Note that cable lengths and cable extensions have effects on electromagnetic compatibility.
- › No maintenance measures are required to maintain the EMC basic safety.

**NOTICE****Negative effects on the EMC due to non-authorized accessories**

- › Use only Dürr Dental parts or accessories specifically approved by Dürr Dental.
- › Using any other accessories may result in increased electromagnetic interference emissions or the unit having reduced electromagnetic immunity, leading to an erroneous operation mode.

**NOTICE****Erroneous operation mode due to use immediately adjacent to other devices or with other stacked devices**

- › Do not stack the unit together with other devices.
- › If this is unavoidable, the unit and other devices should be monitored in order to ensure that they are working correctly.

**NOTICE****Reduced performance characteristics due to insufficient distance between unit and portable HF communication devices**

- › Keep a distance of at least 30 cm between the unit (including parts and cables of the unit) and portable HF communication devices (wireless units) (including their accessories such as antenna cables and external antennas).

2.7 Essential performance characteristics

The VistaScan Ultra View unit does not possess any significant performance characteristics as set out in IEC 60601-1 (EN 60601-1) section 4.3. The unit complies with the requirements according to IEC 60601-1-2:2014.

2.8 Notification requirement for serious incidents

The user / patient is required to report to the manufacturer and the competent authority of the Member State in which the user and/or patient is established any serious incident that has occurred in relation to the device.

2.9 Only use original parts

- › Only use Dürr Dental parts or accessories and optional articles specifically approved by Dürr Dental. Only use original wear parts and replacement parts.



Dürr Dental accepts no liability for damages or injury resulting from the use of non-approved accessories or optional accessories, or from the use of non-original wear parts or replacement parts.

The use of non-approved accessories, optional articles or non-genuine wear parts / replacement parts (e.g. mains cable) can have a negative effect in terms of electrical safety and EMC.

2.10 Transport

The original packaging provides optimum protection for the unit during transport.

If required, original packaging for the unit can be ordered from Dürr Dental.



Dürr Dental will not accept any responsibility or liability for damage occurring during transport due to the use of incorrect packaging, even where the unit is still under guarantee.

- › Only transport the unit in its original packaging.
- › Keep the packing materials out of the reach of children.
- › Do not expose the unit to any strong vibrations or shocks.

2.11 Disposal

An overview of the waste keys for Dürr Dental products can be found in the download area at www.duerrdental.com (document no. P007100155).

Unit



The unit must be disposed of properly. Within the European Union, the unit must be disposed of in accordance with EU Directive 2012/19/EU (WEEE).

If you have any questions about the correct disposal of parts, please contact your dental trade supplier.

Image plate

The image plate contains barium compounds.

- › Dispose of the image plate properly in accordance with the locally applicable regulations.
- › In Europe, dispose of the image plate in accordance with waste code 20 03 01 "Mixed municipal waste".

2.12 Using image plates and light protection covers

- › Only use VistaScan Ultra View with Dürr Dental VistaScan Image Plates IQ and VistaScan Light Protection Covers.

2.13 Using software

- › Only use imaging software that has been authorised by Dürr Dental. Further information can be found on our web site www.duerrdental.com.
- › See section 6 for the supported operating systems and computer requirements.

2.14 Protection from threats from the Internet

The unit is to be connected to a computer that can be connected to the Internet. Therefore, the system needs to be protected from threats from the Internet.

- › Use antivirus software and update it regularly. Look for evidence of possible virus infection and, if applicable, check with the antivirus software and remove the virus.
- › Perform regular data backups.
- › Restrict access to units to trustworthy users, e.g. via a user name and password.
- › Make sure that only trustworthy content is downloaded. Only install software and firmware updates that have been authenticated by the manufacturer.

EN



3 Overview

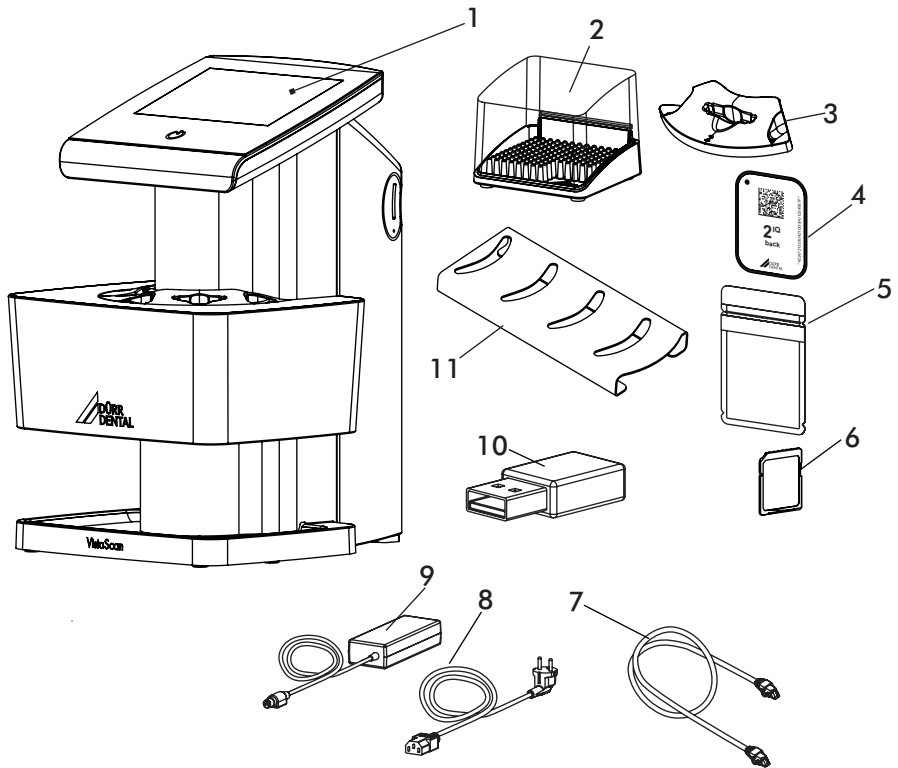

- 1 VistaScan Ultra View Image Plate Scanner
- 2 Image plate storage box
- 3 Plate guide, intraoral
- 4 VistaScan Image Plate IQ
- 5 VistaScan Light Protection Cover Plus
- 6 SDHC memory card
- 7 Network cable
- 8 Country-specific detachable mains cable
- 9 Power supply unit
- 10 Wireless network adapter
- 11 Plate guide storage rack
- 12 Image plate cleaning wipes (not shown)

3.1 Scope of delivery

Unpack each component of VistaScan Ultra View and inspect for physical damage such as scratched panels, damaged connectors, etc. If there is any damage, notify your Dürr Dental authorized dealer immediately so corrective action can be taken. Save all cartons and packing materials to protect VistaScan Ultra View in the event that it is to be transported or shipped in the future. VistaScan Ultra View system includes the basic unit and associated accessory kit as listed below. Verify that all listed items were received. If any item is missing, notify your dealer.

The following items are included in the scope of delivery (possible variations due to country-specific requirements and/or import regulations):

**VistaScan Ultra View
image plate scanner 2170110001**

Accessory kit depending on variant containing:

- Power supply unit/power cable
- Ethernet cable (unshielded)
- SDHC memory card and WLAN stick (installed)
- Plate guides S0 - S4
- VistaScan Image Plate IQ S0
- VistaScan Image Plate IQ S2
- VistaScan Light Protection Cover Plus S0
- VistaScan Light Protection Cover Plus S2
- Plate guide storage rack
- Image plate storage box
- Protection cover
- Image Plate Cleaning Wipes
- VistaScan Ultra View quick start instructions
- Voucher for VistaSoft imaging software

3.2 Accessories

The following items are required for operation of the device, depending on the application:

VistaScan Image Plate IQ

- VistaScan Image Plate IQ S0
- VistaScan Image Plate IQ S1
- VistaScan Image Plate IQ S2
- VistaScan Image Plate IQ S3
- VistaScan Image Plate IQ S4

VistaScan Light Protection Cover Plus

- VistaScan Light Protection Cover Plus S0
- VistaScan Light Protection Cover Plus S1
- VistaScan Light Protection Cover Plus S2
- VistaScan Light Protection Cover Plus S3
- VistaScan Light Protection Cover Plus S4
- VistaScan Light Protection Cover Plus White S0
- VistaScan Light Protection Cover Plus White S2

3.3 Consumables

The following materials are consumed during operation of the device and must be reordered separately:

- Image Plate Cleaning Wipes (10 pcs) CCB351B1001
- FD 333 forte wipes for quick acting disinfection. CDF33FW0150
- FD 350 Classic disinfection wipes CDF35CA0140
- FD 333 rapid surface disinfection CDF333C6150
- FD 322 rapid surface disinfection CDF322C6150
- FD 366 rapid disinfectant for sensitive surfaces CDF366C6150
- ID 213 instrument disinfection CDI213C6150
- ID 212 instrument disinfection. CDI212C6150
- ID 212 forte instrument disinfection CDI212F6150

VistaScan Light Protection Cover Plus

- VistaScan Light Protection Cover Plus S0 (100 pcs). 2130-080-00
- VistaScan Light Protection Cover Plus S1 (100 pcs). 2130-081-00
- VistaScan Light Protection Cover Plus S2 (100 pcs). 2130108251
- VistaScan Light Protection Cover Plus S2 (300 pcs). 2130-082-00
- VistaScan Light Protection Cover Plus S2 (1000 pcs) 2130-082-55
- VistaScan Light Protection Cover Plus S3 (100 pcs). 2130-083-00
- VistaScan Light Protection Cover Plus S4 (100 pcs). 2130-084-00
- VistaScan Light Protection Cover Plus White S0 (100 pcs) 2130-080-50
- VistaScan Light Protection Cover Plus White S2 (300 pcs). 2130-082-50

3.4 Wear parts & replacement parts

Plate guides:

- Plate guide S0 2170101000
- Plate guide S1 2170101100
- Plate guide S2 2170101200
- Plate guide S3 2170101300
- Plate guide S4 2170101400

VistaScan Image plates

VistaScan IQ Pack S0, containing VistaScan Image Plate IQ S0 (2 pcs) + VistaScan Light Protection Cover Plus S0 (1000 pcs)	2130106051
VistaScan IQ Pack S1, containing VistaScan Image Plate IQ S1 (2 pcs) + VistaScan Light Protection Cover Plus S1 (1000 pcs)	2130106151
VistaScan IQ Pack S2, containing VistaScan Image Plate IQ S2 (2 pcs) + VistaScan Light Protection Cover Plus S2 (1000 pcs)	2130106251
VistaScan IQ Pack S3, containing VistaScan Image Plate IQ S3 (2 pcs) + VistaScan Light Protection Cover Plus S3 (1000 pcs)	2130106351
VistaScan IQ Pack S4, containing VistaScan Image Plate IQ S4 (1 pc) + VistaScan Light Protection Cover Plus S4 (100 pcs)	2130106451
VistaScan IQ image plate S0 (2 pcs)	2130104050
VistaScan IQ image plate S1 (2 pcs)	2130104150
VistaScan IQ image plate S2 (4 pcs)	2130104250
VistaScan IQ image plate S2 (12 pcs)	2130104255
VistaScan IQ image plate S3 (2 pcs)	2130104350
VistaScan IQ image plate S4 (1 pc)	2130104450

3.5 Optional articles

The following optional articles can be used with the unit:

Plate guide storage rack	2170103000
Wall bracket.	2170100100
Storage box.	2141-002-00
Bite protector, size 4 (100 pcs) . . .	2130-074-03
VistaPosition PSP Anterior/Posterior Kit Titanium	2130100500
VistaPosition PSP Bitewing Kit Titanium	2130100600
VistaPosition PSP Endo Kit Titanium	2130100700

VistaPosition PSP Anterior/Posterior Kit	2130101500
VistaPosition PSP Bitewing Kit.	2130101600
VistaPosition PSP Endo Kit	2130101700
Mobile Connect (for using apps for mobile appliances, e.g. Dürr Dental Imaging iPad app)	2100-725-12FC

Commissioning and intraoral constancy tests

Intra / extra digital test phantom .	2121-060-54
--------------------------------------	-------------



Information about replacement parts is available from the portal for authorised specialist dealers at:
www.duerrdental.net.

4 Technical data

4.1 Image plate scanner

Power unit electrical details

Voltage	V AC	100 - 240
Frequency	Hz	50/60

Electrical data for VistaScan Ultra View

Voltage	V DC	24
Maximum current	A	1.65
Power consumption	W	< 39.6

Laser source

Laser class IEC 60825-1: 2014		3B
Wavelength	nm	635
Output	mW	< 10

VistaScan Ultra View physical characteristics

Dimensions (W x H x D)	cm	25.1 X 39.1 X 29.2
	in	9.9 X 15.4 X 11.5
Weight	kg	approx. 8.0
	lb	approx. 17.64

Noise levels

Ready	dB(A)	< 40
Scanning	dB(A)	< 60

General values

Laser class (unit) IEC 60825-1: 2014		1
Medical appliance category		I
Maximum feeding width for image plates	cm	5.7
	in	2.24
Maximum theoretical resolution	Lp/mm	approx. 40
Duty Cycle	%	100

Technical data for the RFID module

Frequency	MHz	13.56
Modulation		ASK
Maximum power	mW	400

Network connection

LAN technology		Ethernet
Standard		IEEE 802.3u 100Base-TX
Data rate	Mbit/s	100
Connector		RJ45
Type of connection		Auto MDI-X
Type of cable		≥ CAT5

WLAN connection

WLAN technology		IEEE 802.11b/g
Encryption		WPA /WPA2

Memory card

Type		SDHC
Maximum memory capacity	GB	32
File system		FAT32
Performance class	Class	≥ 4

Ambient conditions during operation

Temperature	°C	+10 to +35
	°F	+50 to +95
Air pressure	hPa	750 to 1060
	in Hg	22.15 to 31.30
Altitude	m	< 2000
	ft	< 6562
Humidity	%	20 to 80

Ambient conditions during storage and transport

Temperature	°C	-20 to +60
	°F	-4 to +140
Air pressure	hPa	750 to 1060
	in Hg	22.15 to 31.30
Humidity	%	10 to 95

Classification

Laser class (unit) in accordance with EN60825-1:2014	1
Medical device class (MDD 93/42/EEC)	Class I
Medical device class (MDR 2017/745)	Class I

Electromagnetic compatibility (EMC) interference emission measurements

High-frequency emissions in accordance with CISPR11	Group I
Interference voltage at the power supply connection CISPR11:2009+A1:2010	Class B
Electromagnetic interference radiation CISPR11:2009+A1:2010	Class A
Emission of harmonics IEC61000-3-2:2005+A1:2008+A2:2009	Class A
Voltage changes, voltage fluctuations and flicker emissions EC61000-3-3:2013	Compliant

Electromagnetic compatibility (EMC) interference immunity measurements cover

Immunity to interference, discharge of static electricity IEC61000-4-2:2008 ± 8kV contact ± 2kV, ±4kV, ±8kV, ±15kV air	Compliant
Immunity to interference, high-frequency electromagnetic fields IEC61000-4-3:2006+A1:2007+A2:2010 3V/m 80MHz-2.7GHz 80%AMat1kHz	Compliant
Immunity to interference, near fields of wireless HF communication devices, IEC61000-4-3:2006+A1:2007+A2:2010 See immunity to interference table, near fields of wireless HF communication devices	Compliant

Immunity to interference table, near fields of wireless HF communication devices

Radio service	Frequency band	Test level
	MHz	V/m
TETRA 400	380-390	27
GMRS 460 and FRS 460	430-470	28
LTE band 13, 17	704-787	9
GSM 800/900, TETRA 800, iDEN 820, CDMA 850 and LTE band 5	800-960	28
GSM 1800, CDMA 1900, GSM 1900, DECT, LTE band 1, 3, 4, 25 and UMTS	1700-1990	28
Bluetooth, WLAN802.11b/g/n, RFID2450 and LTEband7	2400-2570	28
WLAN802.11a/n	5100-5800	9



Electromagnetic compatibility (EMC) interference immunity measurements supply input

Immunity to interference, rapid transient bursts

AC voltage grid
IEC61000-4-4:2012
±2k V
100 kHz repetition frequency

Compliant

Immunity to interference, surges

IEC61000-4-5:2005
±0.5 kV±1kV

Compliant

Immunity to interference, line-conducted disturbances induced by high-frequency fields – AC voltage grid

IEC61000-4-6:2013
3V
0.15-80 MHz
6V

ISM frequency bands
0.15-80 MHz
80% AM at 1kHz

Compliant

Immunity to interference due to voltage dips, short interruptions and voltage variations IEC61000-4-11:2004

Compliant

Electromagnetic compatibility (EMC) Interference immunity measurements SIP/SOP

Immunity to interference, discharge of static electricity

IEC61000-4-2:2008
±8 kV contact
±2 kV ±4 kV ±8 kV ±15 kV air

Compliant

Immunity to interference, rapid transient bursts – I/O, SIP/SOP ports

IEC61000-4-4:2012
±2 kV
100 kHz repetition frequency

Compliant

Immunity to interference, line-conducted disturbances induced by high-frequency fields–SIP/SOP ports

EC61000-4-6:2013
3V
0.15 - 80 MHz
6V
ISM frequency bands
0.15 - 80 MHz
80% AM at 1 kHz

Compliant

4.2 Image plate

Classification

Medical device class IIa

Ambient conditions during operation

Temperature	°C	18 to 45
	°F	64 to 113
Relative humidity	%	< 80

Ambient conditions during storage and transport

Temperature	°C	< 45
	°F	< 113
Relative humidity	%	< 80

Dimensions of intraoral image plates

Size 0	mm	22 x 35
	in	0.87 x 1.38
Size 1	mm	24 x 40
	in	0.94 x 1.57
Size 2	mm	31 x 41
	in	1.22 x 1.61
Size 3	mm	27 x 54
	in	1.06 x 2.13
Size 4	mm	57 x 76
	in	2.24 x 2.99

4.3 Light protection cover

Classification

Medical device class I

4.4 Type plate

The type plate is located on the back cover of the device.

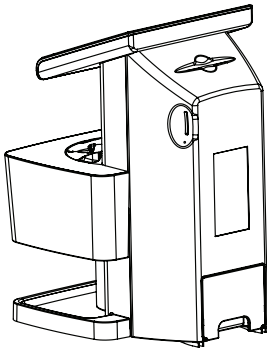

REF Order number

SN Serial number

4.5 Evaluation of conformity

This device has been subjected to conformity acceptance testing in accordance with the current relevant European Union guidelines. This equipment conforms to all relevant requirements.

5 Operation

5.1 Image plate scanner

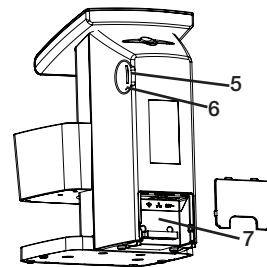
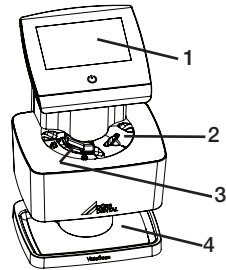

- 1 User interface
- 2 Right image plate input slot
- 3 Left image plate input slot
- 4 Collection tray
- 5 Memory card slot
- 6 Factory reset button
- 7 Connection portal

The image plate scanner is used to read image data stored on the image plate.

The unit can be used in two different ways: via the imaging software (e.g. VistaSoft) on a PC or directly via the touch screen on the unit.

The transport mechanism guides the image plate through the device. The image plate is read using a laser inside the scanner unit. The scanned data is converted into a digital image. If a scanning job is started via the imaging software, the image is automatically transmitted to the computer.

If a scanning job is started via the touch screen, the image is saved to the memory card and then needs to be transferred to the computer.

After scanning, the image plate runs through the erasure unit. Image data still held on the image plate is erased with the aid of bright light.

The image plate is then ejected for re-use.

User interface

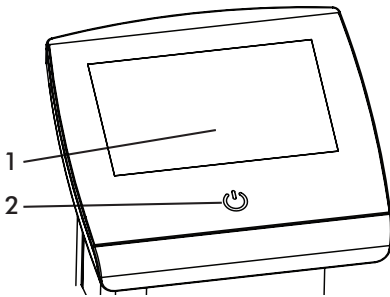

- 1 Touch screen
- 2 On/Off switch

The user interface to the unit consists of an On/Off switch to control operating power and a touch screen. The touch screen allows the unit to be operated when it is not connected to a computer. Instructions can be entered on the touch screen with the tip of a finger.

The Help button is used to open a help page for the relevant task page.

The Messages button is used to call up current messages.

ScanManager



ScanManager can be enabled via Settings > System Settings > Operating Type.

When ScanManager is enabled, more than one X-ray job can be transmitted simultaneously to the unit from different computers. The unit manages the X-ray jobs in a queue from which the relevant X-ray job can be selected using the touch screen and then executed.

Without ScanManager, the unit processes one X-ray job at a time and is blocked until this job has been completed. During this time, no further X-ray jobs can be transmitted to the unit from other computers.



Make sure the different computers used are given unique names so it is known which computer the X-ray job is coming from.

Connections

The connections are located on the rear of the unit, underneath the cover

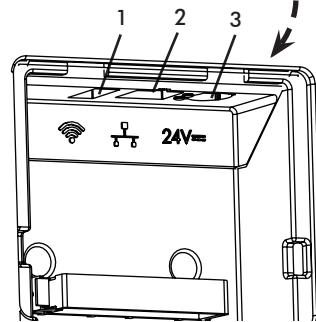
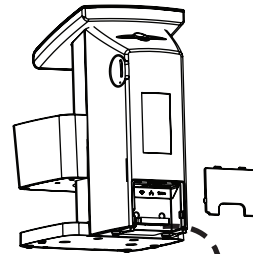

- 1 USB connection (for WLAN stick)
- 2 Network connection (use unshielded type Cat 5e cable only)
- 3 Power supply unit connection

5.2 Image plate



The term image plate is, for reasons of simplified readability, used below as a collective term for the parts listed in section 3.2 and 3.4. The image plate stores X-ray energy, which is re-emitted in the form of light after excitation by the laser. This light is then converted into image information in the image plate scanner.

The image plate has an active side and an inactive side. The image plate must always be exposed on the active side.

When used properly, image plates can be exposed, read and erased hundreds of times provided there is no mechanical damage. The image plate must be replaced if there are any signs of damage, e.g. if the protective layer is damaged or there are visible scratches that could interfere with the diagnosis.



Use only VistaScan Image Plate IQ made by Dürr Dental with the unit. The unit is unable to read any other types of image plates.

Inactive side	Active side
	
<p>White, printed with the word "back" and the size and manufacturer's information</p>	<p>Light blue, with positioning aid </p>

The positioning aid  is visible on the X-ray image and makes it easier to align the image correctly during diagnosis.

5.3 Light protection cover

The term light protection cover is, for reasons of simplified readability, used below as a collective term for associated parts listed in section 3.2 and 3.3.

The light protection cover protects the image plate against light.

5.4 Protection cover

The protection cover protects the device against dust and dirt, for example during extended periods in which it is not in use.

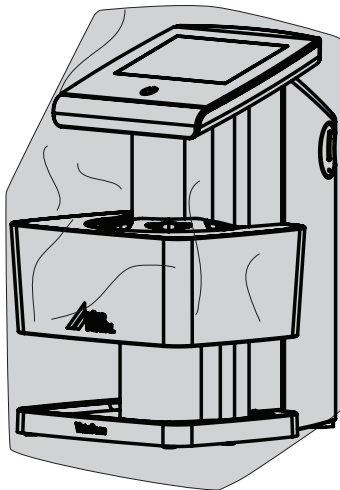

5.5 Storage box

Image plates packaged in light protection covers can be stored in the storage box until they are next used. The storage box protects the image plate and the light protection cover against contamination and dirt.

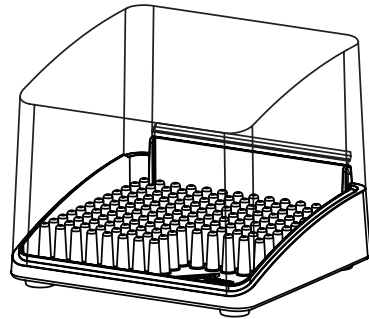

5.6 Bite protector (optional)

The bite protector protects the image plate size 4 as well as the light protection cover against heavy mechanical damage, e.g. if the patient bites down too hard during the X-ray exposure.

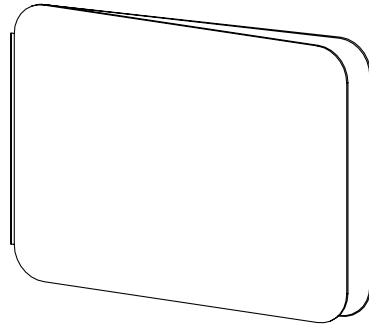



NOTICE

Damage due to user error.

Only qualified specialists or employees trained by Dürr Dental are permitted to install, connect and start using the unit.



NOTICE

Damage due to physical shock.

During operation and the switching off process, ensure that the unit is not moved in any way whatsoever, as the moving parts must be allowed to stop moving completely.

6 Requirements

6.1 Installation/setup room

- VistaScan Ultra View should be set up in a closed, dry and well-ventilated room.
- Room temperature should not fall below +10°C (+50°F) or exceed +35°C (+95°F).



CAUTION

Danger of short circuit due to condensation.

VistaScan Ultra View can only be taken into operation once the unit has warmed up to room temperature and is dry.

- Do not install in a utility room, e.g. in a boiler room or in a wet room.
- Set up in ordinary room light. Avoid direct sunlight and bright interior lighting (more than 1000 lux) directly above the plate guide.
- There must be no source of interference in the room for set-up (e.g. strong magnetic field). Any such disturbances can interfere with the operation of the VistaScan Ultra View.



In order to avoid problems when scanning the image data, VistaScan Ultra View should be set up so that it will not be subject to knocks, vibration or similar.

6.2 Counter top/table set-up

- Provide a stable, flat counter top or table large enough for the scanner work area and able to support the weight of the unit (see 4 Technical data).
- Locate VistaScan Ultra View no further than 1,8 m from a socket outlet.
- Make sure to leave the socket outlet easily accessible, so that the unit may be unplugged if necessary. The power supply is the mains disconnect device.
- Portable and mobile HF communication appliances can interfere with the effectiveness of electrical medical devices.
- Do not arrange the unit so that it is immediately next to, or stacked with other appliances. However, if the unit is operated immediately next to, or stacked with other appliances, make sure to check the unit carefully in the configuration selected to verify normal operation.

6.3 Monitor

The monitor must comply with the requirements for digital X-ray with a high light intensity and wide contrast range.

Strong ambient light, sunlight falling directly onto the monitor and reflections can make it harder or even impossible to perform a diagnosis based on the X-ray images.

6.4 Computer system requirements



The system requirements for the computer systems can be found in the download area at www.duerrdental.com (document no. 9000-618-148).

7 Installation

7.1 Carrying the unit



NOTICE

Risk of damage to sensitive components in the unit as a result of shocks or vibrations

- › Do not move the unit during operation.

Do not lift or move the unit by the top display assembly. Only lift the unit by the sides of the transport drum and/or the bottom base.

7.2 Setting up the unit

Portable and mobile HF communication appliances can interfere with the effectiveness of electrical medical devices.

- › Do not stack the unit next to or together with other appliances.
- › If, however, this unit is operated next to other units or stacked with other units, monitor the unit carefully in the configuration selected in order to ensure normal operation.

The unit can be set up as a tabletop unit or mounted on a wall using the wall bracket.

The load-bearing capacity of the table or wall must be suitable for the weight of the unit (see "4 Technical data").

Setting the unit on a table

- › Place the unit on a firm, horizontal surface.

Installing the unit with wall mounting bracket

The unit can be mounted on a wall with the wall mounting bracket (see 3.3 Optional articles).



For details of the installation refer to the installation instructions for the wall mounting.

7.3 Removing the protective film

- › Grasp one corner of the protective touch screen film and peel it off carefully.

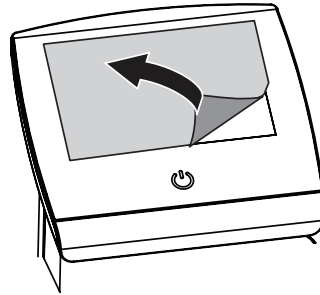

7.4 Checking the memory card



NOTICE

Data loss due to memory card.

- › Only insert or remove the memory card when unit is switched off.
- › Check whether the memory card has been inserted in the unit correctly. If the memory card has been inserted in the unit incorrectly, take it out again and re-insert it properly.

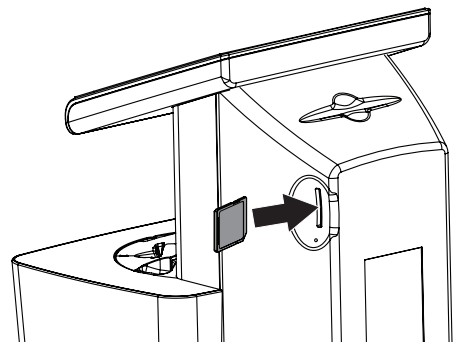

7.5 Software installation

VistaScan Ultra View is designed to be installed by your authorized dealer. The user must provide appropriate and compliant computer hardware where VistaSoft or an authorized third-party imaging program is installed to operate the unit. Smooth operation of the unit's hardware and software can be affected through specific hardware and software incompatibility on site at the client despite meeting system requirements. Where further systems are connected to the PC please note that this may change the system requirements. Observe the system requirements for all connected systems.

7.6 Electrical connections

Safety when making electrical connections

- › The device must only be connected to a correctly installed power outlet.
- › Do not place non-fixed multi-socket units on the floor. Follow the requirements in section 16 of IEC 60601-1 (EN 60601-1).
- › Do not operate any other systems using the same multiple socket.
- › Make sure that none of the electrical cables leading to the unit are under any mechanical tension.
- › Before initial start-up check that the mains supply voltage and the voltage stated on the power supply type plate match (see also "4. Technical data").

Connecting the unit to the mains supply

i The unit has no main power switch. For this reason it is important that the unit is set up in such a way that the plug can be easily accessed and unplugged if required.

Requirements:

- Properly installed power outlet close to the unit (observe the max. mains cable length)
- Easily accessible power outlet
- Mains voltage must match the rating shown on the power supply unit type plate

i Only the supplied power supply unit may be used.

- › Remove the cover from the rear of the device.
- › Attach the matching country-specific mains cable to the power supply unit.

- › Plug the connecting plug of the power supply unit into the socket connection (item 3) of the device.
- › Plug the mains plug into the power outlet.
- › Install the rear cover.

i The cover on the rear must be correctly fitted when the device is operated within the patient environment.

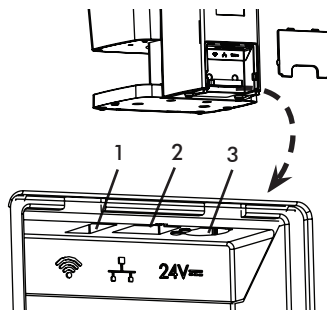

7.7 Connecting the device to the network

Purpose of the network connection

The network connection is used to exchange information or control signals between the unit and software installed on a computer, in order to, e.g.:

- Display parameters
- Select operating modes
- Indicate messages and error situations
- Change unit settings
- Activate test functions
- Transmit data for archiving
- Provide documents concerning the units

The unit can be connected to the network with an unshielded network cable or via WLAN.

Combining devices safely

- The device is designed for safe operation independent of a network. However, some of the functions are not available in this case.
- Incorrect manual configuration can lead to significant network problems. The expert knowledge of a network administrator is required for configuration.
- If, for example, the following changes are made to the network, new risks can arise that require further analysis.
 - Changes in the IT network configuration
 - Connecting additional elements to the IT network
 - Removing elements from the IT network

- "Update" of devices that are connected to the IT network
- "Upgrade" of devices that are connected to the IT network
- The data connection utilises part of the bandwidth of the network. Interactions with other medical devices cannot be completely ruled out. Apply the IEC 80001-1 standard for risk assessment.
- The device is not suitable for direct connection to the public Internet.

Take care when connecting units together or to parts of other systems as there is always an element of risk (e.g. due to leakage currents).

- › Only connect units when there can be no question of danger to operator or to patient.
- › Only connect units when it is safe to do so and when there is no risk of damage or harm to the surroundings.
- › If it is not 100% clear from the unit data sheet that such connections can be safely made or if you are in any doubt, always get a suitably qualified person (e.g. the manufacturer) to verify that the setup is safe.
- › Observe the specifications of IEC 60601-1 (EN 60601-1) when connecting the appliance with other appliances, e.g. a PC system, both in and outside the patient environment.
Only connect peripheral units (such as computers, monitors or printers) that conform at least to the requirements set out in IEC 60950-1 (EN 60950-1).
- › The connected computer must conform to EN 55032 (class B) and EN 55024.

Connecting the unit via the network cable

- › Remove the cover from the rear of the device.
- › Connect the supplied network cable to the network connection (item 2) of the device.

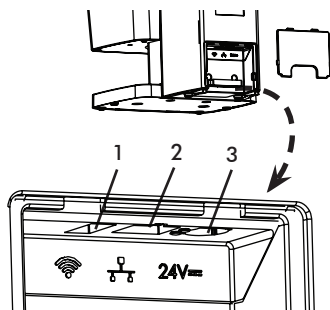

-  The cover on the rear must be correctly fitted when the device is operated within the patient environment.

8 Commissioning



NOTICE
Short circuit due to the build up of condensation

- › Do not switch the unit on until it has warmed to room temperature and is dry.

The unit supports the following imaging programs:

- VistaSoft from Dürr Dental
- Third-party software on request



Always use the latest version of the imaging software VistaSoft when installing the device for the first time. If there is a current version of the software available in the Download Centre (hyperlink <http://www.duerrdental.com/>) use it when installing the device for the first time.

8.1 Configuring the network

Network configuration

Various options are available for network configuration:

- Automatic configuration via DHCP.
- Automatic configuration via Auto-IP for direct connection of unit and computer.
- Manual configuration.
- › Configure the network settings of the unit using the software or, if applicable, the touch screen.
- › Check the firewall and release the ports, if applicable.

Network protocols and ports

Port	Purpose	Service
45123 UDP,	Unit recognition and configuration	
45124 UDP		
2006 TCP	Unit data	
514 ¹⁾ UDP	Event protocol data	Syslog
2005 TCP,	Diagnosis	Telnet,
23 TCP		SSH

¹⁾ Port can vary depending on the configuration.



When the unit is first connected to a computer, it applies the language and time settings of the computer.

8.2 Configuring WLAN on the unit

If the unit is to be operated via WLAN, the WLAN stick included in the scope of delivery must be inserted into the USB connection on the back of the unit (see "Connections"). The connection to the unit then needs to be configured. Proper functioning is only ensured if the WLAN stick supplied by Dürr Dental is used.

In order to establish a secure WLAN connection, we recommend encrypting the WLAN network with WPA2.

The quality and transmission range of the WLAN connection can be reduced by environmental conditions (e.g. thick walls, other WLAN devices). When selecting a suitable location for set up, take the signal strength into consideration.

Requirements:

You need to be logged-in on the unit as Administrator or Service Technician (Settings > Access Levels > Administrator/Service Technician).

- › Check the WLAN settings with your Network Administrator.
- › Tap the following on the touch screen: Settings > System Settings > Network.
- › Under Interface select the option WLAN and confirm with OK.
- › Configure the WLAN.
- › Confirm with OK.

8.3 Configuring the unit

Configuration is performed directly in VistaSoft.

- ›  **Select the unit.**
- › Select the connected unit in the list.

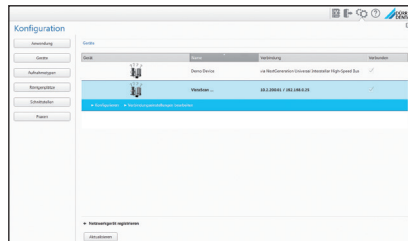

- › Click on **Edit connection settings**.
- › The unit name (designation) can be changed and information queried working under **General**.
- › An IP address can be entered manually and DHCP can be activated / deactivated working under **Connection**.

Entering a fixed IP address (recommended)



To reset the network settings, keep the unit reset key located near the SD card slot at the right side of the unit pressed using an office paper clip or similar for 15 - 20 seconds until the screen turns black while switching on.

- › Working under **Connection**, deactivate DHCP.
- › Enter the IP address, subnet mask and gateway.
- › Navigate back to **Units** via the navigation bar or close Flyout using .

The configuration is saved.

Testing the device

You can scan in an X-ray image to check that the unit is properly connected.

- › Open VistaSoft.
- › Create an X-ray station for the connected unit.
- › Log in the demo patient (patient ID: DEMO0001).
- › Select the image type (e.g. Intraoral).
- › Scan an image plate, see "10.3 Scanning the image data".

8.4 X-ray unit settings

Intraoral X-ray units



If 60 kV can be set on the X-ray unit, this setting is preferred.
The standard exposure values for F-speed film (e.g. Kodak Insight) can be used.

The following table shows the standard values for the exposure time and the dose area product of an image plate for an adult patient. The values of exposure time and dose area product are based on used of a VistalIntra as X-ray unit.

μGy = Image receiver dose

mGycm^2 = Dose area product

	DC emitter 60kV/7mA Tube Length 20cm						
	Without X-rayfield limitation			X-ray field limitation 2x3		X-ray field limitation 3x4	
	60kV	mGycm ²	μGy	60 kV	mGycm ²	60 kV	mGycm ²
Incisors	0.10 s	18.3	538.7	0.10 s	3.8	0.10 s	7.7
Premolars	0.14 s	25.6	766.8	0.14 s	5.4	0.14 s	10.8
Molars	0.19 s	34.8	1037	0.19 s	7.3	0.19 s	14.7
Bite wing	0.20 s	36.6	1090	0.20 s	7.7	0.20 s	15.5

› Check and adjust the specific X-ray unit in accordance with the standard values.

DC emitter 70kV/6mA Tube Length 30cm							
	Without X-ray field limitation		X-ray field limitation 2x3		X-ray field limitation 3x4		
	70 kV	mGycm ²	μGy	70 kV	mGycm ²	70 kV	mGycm ²
Incisors	0.15 s	13.7	445	0.15 s	4.9	0.15 s	5.8
Premolars	0.20 s	18.2	594	0.20 s	3.8	0.20 s	7.7
Molars	0.27 s	24.6	806	0.27 s	5.2	0.27 s	10.4
Bite wing	0.28 s	25.5	834	0.28 s	5.6	0.28 s	10.8

8.5 Acceptance tests

The required tests (e.g. acceptance tests) must be carried out in accordance with local rules and regulations.

- › Find out which tests are required.
- › Carry out testing in accordance with local rules and regulations. (See article 9000-618-133)

Acceptance test



The Intra / Extra Digital test phantom is required for acceptance tests with the image plate and sensor as receivers, and possibly also the corresponding test body holder.

- › Before the unit is started up and used for the first time, the acceptance test of the X-ray system must be carried out in accordance with national regulations.

The consistency tests, which must be carried out at regular intervals by the dental professional, are based on the results of the acceptance test.

Electrical safety checks

- › Carry out the electrical safety check according to the national law (e.g. in accordance with IEC 62353).
- › Document the results.
- › Carry out and document the instruction and handover for the unit.



A sample handover report is included in the appendix.



9 Operating the touch screen



WARNING

Damage to the touch screen due to incorrect handling

- › Only operate the touch screen using the tip of a finger.
- › Do not use any sharp instrument (e.g. ballpoint pen) to operate the touch screen.
- › Do not use the touch screen if scratched or cracked.
- › Protect the touch screen from water.

Select a button or input field by tapping the touch screen with the tip of a finger. For further information on any window, select the Help field.

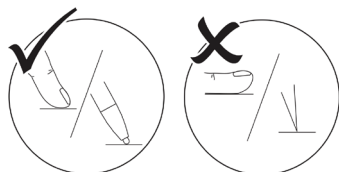

9.1 Navigating

If the contents of the window cannot be completely displayed on the touch screen, a scroll bar appears. Touch, hold and slide the bar up or down to move the displayed section in the window. Scrolling may also be done by continuously pressing the arrow keys to move the displayed section up or down.



- › Tap or to move the displayed section of the window.

9.2 Using menus

The integrated menus within the main window contain additional commands that can be selected as required. Touch to open the menu.

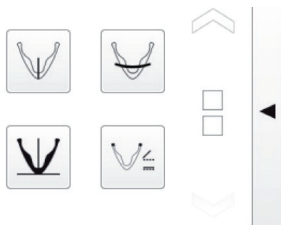

9.3 Entering text in the field



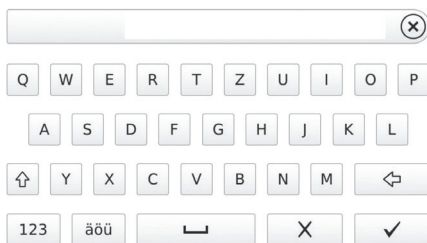

Where fields require an input, touch the field. The keyboard window will open.



- Switch to numbers/special symbols
- Shift key
- Switch to special characters
-
- Delete
- Cancel input and close window
- Confirm input and close window
- Space bar

9.4 Calling up messages on the screen

The Messages view shows a history of all previous messages. Messages are divided into the following categories:

	Malfunction	Unit no longer functions. When the error has been remedied, it may be necessary to acknowledge the error message.
	Warning	After acknowledgment the unit will continue to work, but only with limited functions.
	Information	Informs the operator that important information is available, e.g. about the current status of the device.
		The unit continues to operate.
	Notice	Information for the operator. The unit continues to operate.
	Fault-free operation	





Tap Messages.

- > This displays the message.
- > If there are several messages, the most current with the highest priority is displayed first.

For more information about the message, tap Help.

9.5 System settings

System settings can be viewed and edited via the touch screen icons listed below.

	Language	Select the output language of the unit: English, German
	Date & Time	Edit the settings for date and time
		View the MAC address of the unit
	Network	Edit the name of the network and interface Activate or deactivate DHCP Edit IP address, subnet mask and gateway
	Touch screen	Set the brightness of the monitor Touch screen calibration

Choosing the language

- > Touch the required language.
- > Touch OK.

Editing the date & time

- > Touch Date and Time.
- > Enter the values using the arrows.
- > Touch OK.

 If the unit is operated from a PC, the display of date and time is automatically synchronised with the selected regional display for the PC.

Editing settings for the network

- > Touch Name.
- > Enter the values via the keyboard.
- > Touch Interface.
- > Select LAN or WLAN via the arrows.
- > Touch OK.
- > Touch DHCP to activate or deactivate.

The IP address, subnet mask and gateway can only be edited if DHCP is deactivated

- > Touch IP address, subnet mask and Gateway
- > Enter values via the keyboard

Editing settings for the touch screen

- › Touch Brightness.
- › Enter the values via the arrows.
- › Touch OK.
- › Touch Calibrate touch screen.
- › Follow the instructions on the monitor.
- › Touch OK.

9.6 Main menu

The following actions can be selected:









	Image editing	View and edit X-ray images saved on the SD card: Brightness, contrast, rotate, invert, magnify, reduce.		To reduce the image, swipe across the X-ray image from right to left. Move the magnified image section. Touch the magnifying glass symbol until the display ± disappears. Touch the X-ray image and move to the required image section.
	Scanning	Delete X-ray image The scanning order starts with specification of the patient and imaging information. X-ray image is stored on the SD card together with the image information under the name of the patient.		Rotate the image anti-clockwise by 90°
	Intra Rapid Rapid scanning	The scanning order starts without specification of the patient and image information. The X-ray image is stored on the SD card in a folder with date and time.		Rotate the image clockwise by 90°
				Rotate the image anti-clockwise by 180°
				View the histogram for the selected image section of the X-ray image. The measurement area is within the square. The number displays the maximum grey value in the centre of the measurement area. The red line displays the vertical grey value distribution. The green line displays the horizontal grey value distribution. Touch the histogram and move to the required image section. To deactivate the histogram, touch the histogram pictogram in the menu.
				Edit the brightness of the image. To increase the brightness, move the controller to the left or touch the left arrow several times. To reduce the brightness, move the controller to the right or touch the right arrow several times.

Image editing

- › Touch Edit or touch the X-ray image twice in quick succession (double click).



Magnify or reduce the image

Touch the magnifying glass icon until the display ± appears in the magnifying glass.

To magnify the image, swipe across the X-ray image from left to right. The size ratio is displayed on the right next to the magnifying glass.



Edit the contrast of the image
To increase the contrast, move the controller to the right or touch the right arrow several times.
To reduce the gamma value, move the controller to the left or touch the left arrow several times.



Edit the gamma value of the image

To increase the gamma value, move the controller to the right or touch the right arrow several times.

To reduce the gamma value, move the controller to the left or touch the left arrow several times.



Switch between the positive and negative display of the image



Vertically invert the image



Horizontally invert the image



Display help



Save all changes



Undo last change



Cancel image processing
All changes carried out after the last save are lost

10 Correct use of image plates and light protection covers



WARNING

Risk of cross contamination when not using the light protection cover or when using the light protection cover more than once

- › Do not use an image plate without a light protection cover.
- › Do not use the light protection cover more than once (disposable item).



CAUTION

The image data on the image plate is not permanent

The image data is altered by light, natural X-ray radiation and scattered X-ray radiation. This will lead to a reduction in diagnostic information and clarity.

- › Read the image data within 30 minutes of exposure.
- › Never handle exposed image plates without the light protection cover.
- › Do not subject an exposed image plate to X-ray radiation before or after the scanning process.
- › Do not X-ray during the scanning process if the unit is in the same room as the X-ray tube.



CAUTION

Image plates are toxic

Image plates that are not packed in a light protection cover can lead to poisoning when placed in the mouth or swallowed.

- › Only place image plates in the patient's mouth in a light protection cover.
- › Do not swallow the image plate or parts of it.
- › If the image plate or parts of it have been swallowed, consult a specialist doctor immediately and remove the image plate.
- › If the light protection cover has been damaged in the patient's mouth, rinse the mouth thoroughly with lots of water. Do not swallow the water in the process.

- › Image plates must only be read using an image plate scanner that is approved by Dürr Dental.
- › Image plates are flexible like X-ray film. However, the image plates should not be bent.

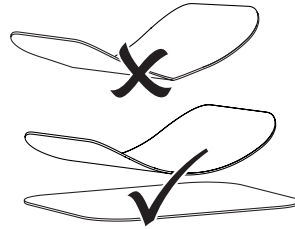

- › Do not scratch the image plates. Do not subject the image plates to pressure from hard or pointed objects.

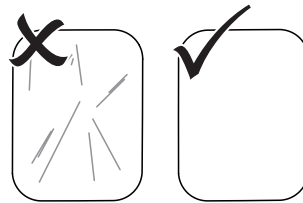

- › Do not soil the image plates.
- › Protect the image plates against sunlight and ultraviolet light.
Store image plates in a light protection cover of the correct size.
- › Image plates will be pre-exposed on exposure to natural radiation and stray X-ray radiation. Protect erased and exposed image plates from X-ray interference.
If the image plate has been stored for longer than one week, erase the image plate prior to use.
- › Do not store image plates under hot or damp conditions. Observe the correct ambient conditions (see "4 Technical data").
- › When used properly, image plates can be exposed, read and erased several hundred times provided there is no mechanical damage.
Replace the image plate if there are any signs of damage, e.g. if the protective layer is damaged or there are visible scratches that impair the quality of the diagnosis.
Also replace the image plate if the RFID tag is damaged or becoming detached.
- › Image plates that have a production or packaging defect will be replaced by Dürr Dental in the same quantity. Claims can only be accepted within 7 working days after receipt of the goods.
- › Clean image plates properly (see "12 Cleaning and disinfection").

11 Operation

11.1 Changing the plate guide.

- › VistaScan Ultra View can be used to scan image plates Size 0, Size 1, Size 2, Size 3 and Size 4.
- › Each size of image plate requires the matching size plate guide.
- › The size of the image plate is clearly marked on the plate guide.
- › Remove the plate guide by simply lifting it from the transport.
- › Install the plate guide by aligning the position pins and placing the guide into the guide holes. It will snap into place due to the magnet installed.



CAUTION

If a plate guide is removed, a warning message will appear on the LCD screen that the plate guide is missing.

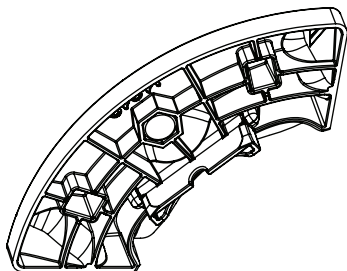
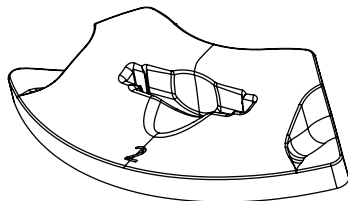

11.2 X-ray

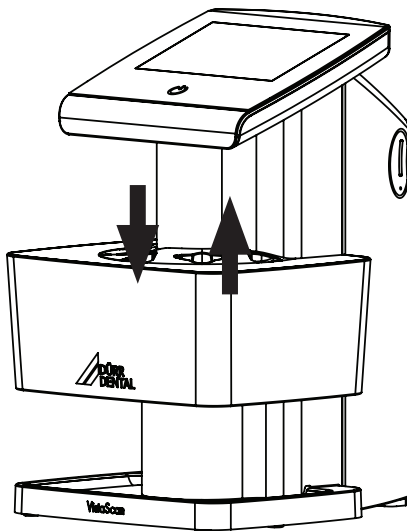

The procedure is described using a size 2 VistaScan Image Plate IQ S2 as an example.

Required accessories:

- VistaScan Image Plate IQ
- VistaScan Light Protection Cover Plus of the same size as the image plate
- Plate guide and image plate are same size



WARNING

Risk of cross contamination when not using the light protection cover or when using the light protection cover more than once

- › Do not use an image plate without a light protection cover.
- › Do not use the light protection cover more than once (disposable item).

Preparing the X-ray

- The image plate has been cleaned.
- The image plate is not damaged.
- The RFID tag is attached to the image plate. If the RFID tag peels off, replace the image plate.
- › If using it for the first time or if it has been stored for over a week: erase the image plate (see "11.5 Erasing the image plate").

- › Completely slide the image plate into the light protection cover. The white (inactive) side of the image plate must be visible.

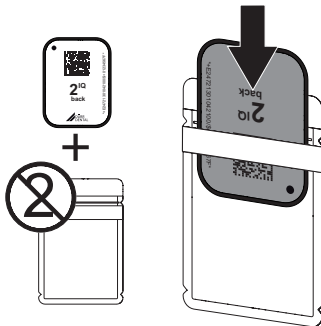

- › Pull off the adhesive strip, fold down the flap and close the light protection cover tightly by pressing together firmly.
- › In the case of image plates Plus size 4, place the bite protector around the light protection cover with image plate if necessary.

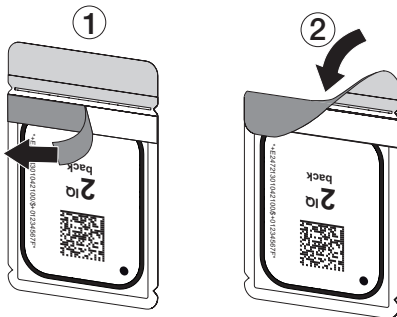

- › The light protection cover must be disinfected using a suitable disinfectant wipe immediately before positioning it inside the patient's mouth (see "12 Cleaning and disinfection").

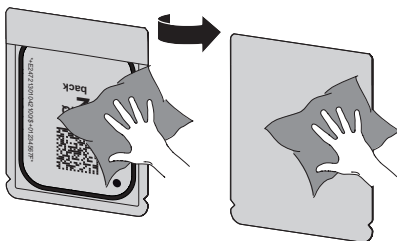

- › Allow the light protection cover to fully dry.
- › In the case of image plates Plus size 4, place the bite protector around the light protection cover with image plate if necessary.

Taking the X-ray



NOTICE

Damage to the image plate caused by a sharp-edged holding system

- › Only use holding systems that will not damage the light protection cover or the image plates in any way.
- › Do not use holding systems with sharp edges.



Wear protective gloves.

- › Place the image plate in the light protection cover into the patient's mouth.

When doing this, make sure that the active side of the image plate points towards the X-ray tube.

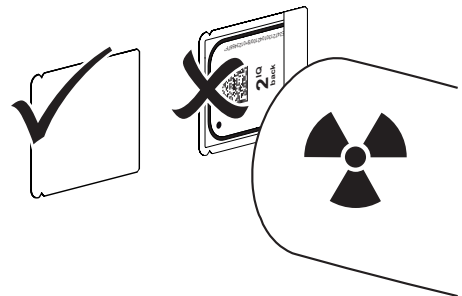

- › Set the exposure time and setting values on the X-ray unit (see "8.4 X-ray unit settings").
- › Record an X-ray image.
The image data must be scanned within 30 minutes.

Preparing for scanning



CAUTION

Light erases the image data on the image plate

- › Never handle exposed image plates without the light protection cover.



Wear protective gloves.

- › Remove the image plate with the light protection cover from the patient's mouth.



WARNING

Contamination of the unit

- › Clean and disinfect the light protection cover before removing the image plate.

- > In the event of heavy soiling, e.g. from blood, dry clean the light protection cover and protective gloves, e.g. wipe with a clean cellulose cloth.
- > Disinfect the light protection cover and protective gloves with a suitable disinfection wipe; see "12.2 Light protection cover".

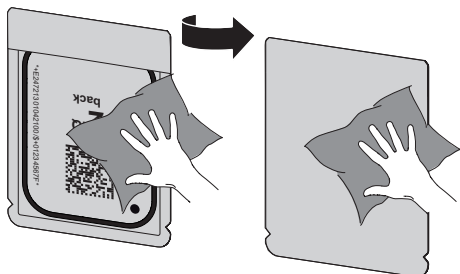

- > Pull off the protective gloves and disinfect the hands and allow the light protection cover to fully dry.



NOTICE
Powder from the protective gloves on the image plate can damage the unit during scanning

- > Completely clean all traces of the protective glove powder from your hands before handling the image plate.

- > Tear off the light protection cover.



11.3 Scanning the image data via a computer

Starting the image plate scanner and software



The reading-out process is described using the VistaSoft imaging software. For further information on using the imaging software, refer to the relevant manual.

- > Press the On/Off switch  to switch on the device.
- > Switch on the computer and monitor.
- > Start VistaSoft.
- > Select the patient.
- > Select the corresponding image type in the menu bar.
- > Select the device.
- > Set acquisition mode.

Recording starts immediately. When ScanManager is enabled the X-ray jobs can be selected via the touch screen of the unit.

Result:

The touch screen will display an animated visual symbol requesting insertion of the image plate.



Only insert the image plate when the bar above the animated sequence has turned to green.

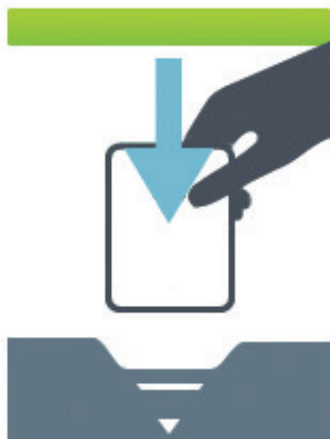

NOTICE
VistaScan Ultra View only scans images using VistaScan Image Plate IQ made by Dürr Dental.

- > Use only VistaScan Image Plate IQ.

Scanning the image plate.

- › Place the light protection cover with the image plate centrally and straight into the plate guide.
- › The opened side of the light protection cover faces down; the inactive (back) side of the image plate faces the operator.
- › The image plate must not be pulled out of the light protection cover before replacement on the input unit. There is the risk of image information being erased by ambient light (see “10 Correct use of image plates and light protection covers”).
- › Slide the image plate out of the light protection cover downwards into the unit. Press the plate all the way down until the transport mechanism takes over and moves the plate on its own.
- › Remove the empty light protection cover.

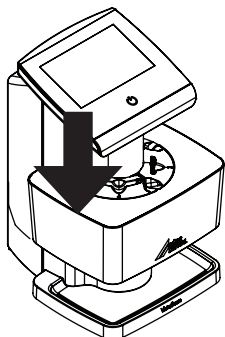
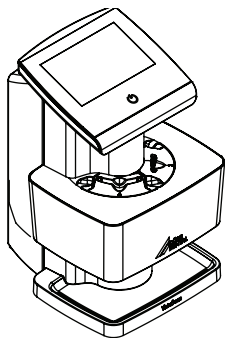

- › The image data is automatically transmitted to the imaging software. Scanning progress is displayed on the touch screen.

After it has been scanned, the image plate is erased and drops into the collection tray.

- › Save the X-ray image.
- › Remove the image plate and prepare to take a new X-ray.

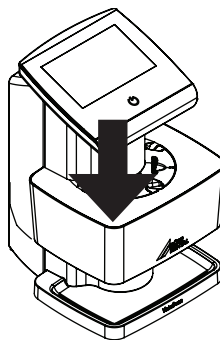

11.4 Scanning image data via the touch screen on the unit

Starting the image plate scanner

When scanning the image data via the touch screen, there is no need for a PC connection. The image data is stored locally on the memory card. In order to transfer the image data to the imaging software, the unit must be connected to a computer.

Scanning via the touch screen can be done in two ways:



Scanning:

Before scanning the image data, the patient data and exposure settings of the image are entered and then saved with the image data.

If no patient data and exposure settings of the image are entered then the image is saved to a folder with date and time.



Rapid scanning:

The image data is saved to a folder with the date and time and no additional information.



Use **Help** on the touch screen for further information on operating the unit via the touch screen.

Requirements:

- Memory card (SDHC, max. 32 GB) in the slot on the unit.
- › Press  to switch on the unit.

Start scanning:

- › On the touch screen tap **Scan**.
- › Enter the patient data.
- › Select the image settings and scanning mode.

The touch screen will display an animated visual symbol requesting insertion of the image plate.

-  Only insert the image plate when the bar above the animated sequence has turned to green.



Example of the animation requesting insertion of the image

Start rapid scanning:

- › On the touch screen tap **Rapid scan**.
- › Select the scanning mode.

Scanning the image plate

-  To avoid the risk of mixing up X-ray images, only scan the X-ray images from the selected patient.
- › Place the light protection cover with the image plate centrally and straight into the plate guide with the opened side of the light protection cover facing down. The inactive side of the image plate should face the operator.
- › Slide the image plate out of its light protection cover downwards into the device until the image plate is automatically drawn in.

The light protection cover is held in place by the plate guide and is not transported into the unit. Scanning progress is displayed on the touch screen. The image data is automatically saved to the memory card.

-  The touch screen only shows a preview, which provides an initial impression of the X-ray image. For the purpose of diagnosis the X-ray image must be viewed on a diagnostic monitor.

After it has been scanned, the image plate is erased and drops into the collection tray.

- › Remove the empty light protection cover.
- › Remove the image plate and prepare it for taking a new X-ray.

Transmitting image data to the computer

X-ray images generated via the touch screen on the unit are saved to the SD card. These X-ray images can be imported to the imaging software via a network connection (e.g. VistaSoft).

- › Connect the unit to the network.
- › Start the imaging software.
- › Start the image import via the imaging software (further information can be found in the manual of the imaging software).
- › Save the image data.

The image data on the memory card is erased automatically as soon as the transfer has been successfully completed.

11.5 Erasing the image plate.

The image data is automatically erased after scanning.

The special ERASE mode only activates the erasure unit of the image plate scanner. No image data is read.

The image plate needs to be erased using the special mode in the following cases:

- The first time the image plate is used, or if its stored for longer than a week.
- Due to an error, the image data on the image plate has not been erased (software error message).

Erasing the image plate via a computer

- › Select the special ERASE mode in the software.
- › Scan the image plate (see "11.3 Scanning the image data via a computer").

Erasing the image plate via the touch screen.

- › On the touch screen tap Rapid scan.
- › Select the scanning mode ERASE.
- › Scan the image plate (see "11.4 Scanning image data via the touch screen on the unit").

If you do not want the image data to be erased, this function can be disabled for the current scanning process by selecting Disable erasing light on the touch screen of the unit.

11.6 Switch off the unit.

Press the On/Standby switch for 2 seconds. As soon as the unit has shut down it switches off completely. The LCD screen turns off and the LEDs go out.

 After switching off the unit, wait 10 seconds before switching the unit on again.

Use of a protection cover

The protection cover protects the device against dirt and dust during extended periods in which it is not used.



WARNING **Danger of suffocation**

- › Store the protection cover out of the reach of children.

- › Pull the protection cover over the device so that it is completely covered. Make sure that the markings are at the front.

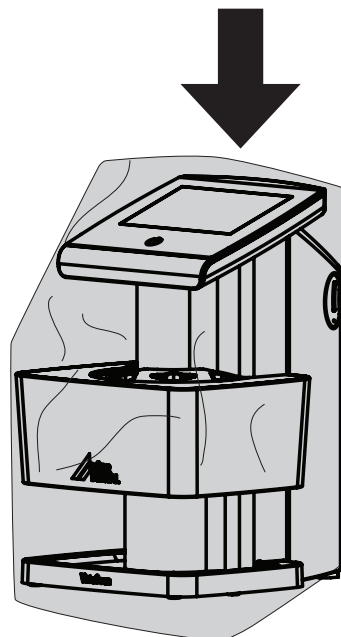

- › Store the protection cover in a safe place when it is not in use.

12 Cleaning and disinfection

When cleaning and disinfecting the unit and its accessories, observe country-specific directives, standards and specifications for medical products as well as the specific specifications for dental practices and clinics.



NOTICE

The use of unsuitable agents and methods can damage the unit and accessories.

Do not use any products based on phenolic compounds, halogen-releasing compounds, strong organic acids or oxygen-releasing compounds, as they may damage the materials.

- › Dürr Dental recommends using disinfectants from the Dürr Dental product range. Only the products specified in these instructions have been subjected to material compatibility testing by Dürr Dental.
- › Read the operating instructions for the disinfectants.



Wear protective gloves.

12.1 Image plate scanner

Unit surfaces

The unit surfaces must be cleaned and disinfected of any contamination or visible soiling.

Dürr Dental recommends using the disinfectants FD 322, FD 333, FD 350 and FD 366 sensitive.



NOTICE

Liquid can cause damage to the unit.

- › Do not spray the unit with cleaning and disinfectant agents.
 - › Make sure that liquid does not get inside the unit.
- › Remove any soiling with a soft, lint-free cloth that has been dampened with cold tap water.
 - › Disinfect the surfaces using a disinfection wipe. Alternatively, use disinfectant on a soft, lint-free cloth.

12.2 Light protection cover

The surface of the unit must be cleaned and disinfected if it is contaminated or visibly soiled.

- › Disinfect the light protection cover using a disinfectant before and after placement. Dürr Dental recommends FD 333 forte wipes (virucidal), FD 350 (limited virucidal activity) and FD 322 premium wipes (limited virucidal activity).
- › Allow the light protection cover to completely dry before using it.

12.3 Image plate

Cleaning and disinfection wipes are unsuitable for cleaning image plates and may cause damage to them.

Only use a cleaning agent that is compatible with the materials:

Dürr Dental recommends the image plate cleaning wipe (see "3.4 Consumables"). Only this product has been subjected to material compatibility testing by Dürr Dental.



NOTICE

Heat or humidity will damage the image plate.

- › Do not steam sterilise the image plate.
- › Do not immersion-disinfect the image plate.
- › Only use cleaning agents that are compatible with the materials.

12.4 Plate guides

The plate guides must be cleaned and disinfected if there are indications of contamination or visible dirt.

Dürr Dental recommends using the disinfectants FD 322, FD 333, FD 350, and FD 366 sensitive. Use the following cleaning and disinfecting immersion disinfectants:

- › ID 213 Instrument disinfection
- › ID 212
- › ID 212 forte



NOTICE

Heat can damage plastic parts.

- › Do not use a thermal disinfectant or steam sterilizer on any device.

- › Soiling on both sides of the image plate should be cleaned off with a soft, lint-free wipe prior to every use.
- › Remove stubborn or dried-on dirt with the image plate cleaning wipe. When doing this, observe the instructions for use for the cleaning wipe.
- › Allow the image plate to completely dry before using it.

12.5 Storage box with image plate storage tray

Clean and disinfect the surface of the storage box and the internal image plate storage tray in the event of contamination or visible soiling.

Dürr Dental recommends the following disinfectant for the storage box:

FD 366 sensitive

Dürr Dental recommends the following disinfectants for the image plate storage tray:

FD 350 and FD 366 sensitive

- › Clean the surface of the storage box and the image plate storage tray with a soft, lint-free cloth that has been dampened with cold tap water.
- › Disinfect the storage box using a disinfection wipe. Alternatively, use disinfectant on a soft, lint-free cloth.
- › Disinfect the image plate storage tray using a disinfection wipe.

Alternatively, the image plate storage tray can also be treated in a thermal disinfectant or steam sterilizer. Do not exceed a temperature of 134°C when doing this.

13 Maintenance

13.1 Yearly scheduled maintenance

Like all precision products, the VistaScan Ultra View requires a certain amount of care on a regularly scheduled basis. A well-organised maintenance program aids dependable equipment operation and reduces problems to a minimum. Yearly service carried out by a Dürr Dental trained and certified technician will ensure continued uninterrupted operation. These routine checks help to detect general overall wear, and replacement of parts can often be made before a problem occurs.

13.2 Recommended maintenance schedule



Prior to working on the device or in case of danger, disconnect it from the mains (e.g. pull the mains plug).



Only trained specialists or personnel trained by Durr Dental may service the unit.

The recommended maintenance intervals are based on using the device for 15 intraoral images per day on 220 working days per year.

Maintenance interval	Maintenance work
Annually	› Visually inspect the device.
	› Check the image plates for signs of scratches and change if necessary.
	› Check the belt drives, transport belts and springs, and replace if necessary.
	› Remove dust and dirt from accessible parts.
Every 3 years	› Carry out a system check.
	› Change the upper and lower roller housing assemblies
	› Change the drive belt.



14 Tips for operators and service technicians



Any repairs exceeding routine maintenance may only be carried out by qualified personnel or our service.



Prior to working on the device or in case of danger, disconnect it from the mains (e.g. pull the mains plug).

14.1 Poor X-ray image

Problem	Probable cause	Solution
No X-ray image shown on the monitor after scanning	Image plate not fed in straight and inactive side was scanned	› Scan the image plate again immediately, making sure you feed it in correctly in the process.
	Image data on the image plate has been erased, e.g. by ambient light	› Always scan the image data of the image plate as soon as possible.
	Fault on the unit	› Contact technician.
	No image data on image plate, image plate not exposed	› Expose the image plate.
	X-ray unit is faulty	› Contact technician.
X-ray image too dark	X-ray dose too high	› Check X-ray parameters.
	Incorrect brightness/contrast settings in the software	› Adjust the brightness of the X-ray image in the software.
X-ray image too bright	Exposed image plate has been exposed to ambient light	› Always scan the image data of the image plate as soon as possible.
	X-ray dose too low	› Check X-ray parameters
	Incorrect brightness/contrast settings in the software	› Adjust the brightness of the X-ray image in the software.
X-ray image only shadowy	The X-ray dose on the image plate was insufficient	› Increase X-ray dose.
	Amplification (HV value) is set too low in the software	› Increase amplification (HV value).
	Unsuitable scanning mode selected	› Select a suitable scanning mode.
	The setting for the threshold value is too high	› Reduce the threshold value.
X-ray image is mirrored inverted	Image plate incorrectly inserted in plate guide or light protection cover.	› Insert image plate correctly.
	Image plate not placed straight.	› Position the image plate correctly.

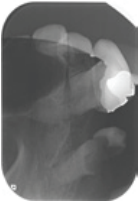
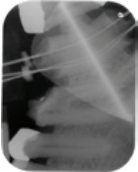
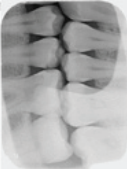
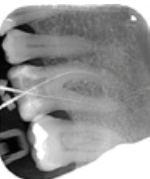
Problem	Probable cause	Solution
<p>Ghosting or double exposure on X-ray image</p> 	<p>Image plate exposed twice</p> <p>Image plate not properly erased</p>	<ul style="list-style-type: none"> ➤ Only expose the image plate once ➤ Check the erasure unit for proper function. ➤ Inform a service technician if the problem persists.
<p>X-ray image mirrored in one corner</p> 	<p>Image plate bent during X-ray exposure</p>	<ul style="list-style-type: none"> ➤ Do not bend the image plate
<p>Shadow on the X-ray image</p> 	<p>Image plate removed from the light protection cover before scanning</p>	<ul style="list-style-type: none"> ➤ Do not handle image plates without a light protection cover. ➤ Store the image plate in a light protection cover.
<p>X-ray image cut off, part missing</p> 	<p>A metal part of the X-ray tube is in front of the X-ray beam</p> <p>Faulty edge masking in imaging software</p>	<ul style="list-style-type: none"> ➤ Recording an X-ray image, make sure there are no metal parts between the X-ray tube and the patient. ➤ Check X-ray tube. ➤ Deactivate edge masking.
<p>Software unable to combine the data to make a complete image</p>	<p>The X-ray dose on the image plate was insufficient</p> <p>Unsuitable scanning mode selected</p> <p>Amplification (HV value) is set too low in the software</p> <p>The setting for the threshold value is too high</p>	<ul style="list-style-type: none"> ➤ Increase X-ray dose. ➤ Select a suitable scanning mode. ➤ Increase amplification (HV value). ➤ Reduce the threshold value

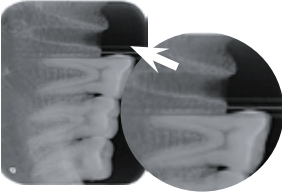
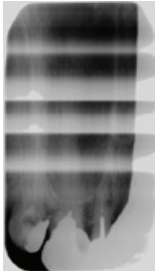
Problem	Probable cause	Solution
X-ray image has strips on image	<p>Image plate has been pre-exposed, e.g. by natural radiation or stray X-ray radiation</p> <p>Parts of image plate exposed to light during handling</p> <p>Image plate dirty or scratched</p>	<ul style="list-style-type: none"> › If the image plate has been stored for more than one week, erase the image plate prior to use. › Do not expose exposed image plates to bright light. › Scan image data within half an hour after the exposure. › Clean the image plate. › Replace scratched image plate.
Bright stripes in the scanning window	Too much incident ambient light during the scanning process	<ul style="list-style-type: none"> › Darken the room. › Turn the unit so that no light is directly incident on the input unit.
Horizontal, grey lines in the X-ray image, extending beyond the left and right image edge	Transport slipping	<ul style="list-style-type: none"> › Clean the transport mechanism, replace the transport belts if necessary.
	Wrong light protection cover or image plate used	<ul style="list-style-type: none"> › Only use original accessories.
X-ray image is stretched lengthwise with bright, horizontal stripes		

EN

Problem	Probable cause	Solution
---------	----------------	----------

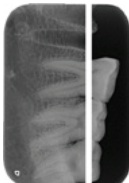
<p>X-ray image split vertically into two halves</p> 	<p>Dirt in the laser slit (e.g. hair, dust)</p>	<p>› Clean the laser slit.</p>
--	---	--------------------------------

<p>X-ray image with small bright spots or clouding</p>	<p>Micro scratches on the image plate</p>	<p>› Replace the image plate.</p>
--	---	-----------------------------------

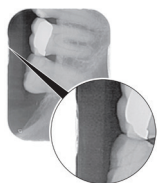
<p>Lamination of the image plate detaches at the edge</p> 	<p>Wrong retainer system used</p>	<p>› Only use original image plate and film retainer systems.</p>
	<p>Image plate handled incorrectly</p>	<p>› Use the image plate correctly. › Comply with the operating instructions of the image plate and film retainer systems.</p>

<p>Imaging software displays two acquisition images as one image</p> 	<p>Two image plates were fed into the unit simultaneously. The status of the feeding indicator bar display was not regarded.</p>	<p>Only one Image plate can be fed into the unit when the feeding indicator bar display is green. (See section 11.3 and 11.4)</p>
--	--	---

14.2 Software error

Problem	Probable cause	Solution
---------	----------------	----------

<p>Too much ambient light</p>	<p>Unit is exposed to too much light</p>	<p>› Darken the room. › Turn the unit so that no light can directly enter into the entry slot.</p>
<p>Over temperature</p>	<p>Laser or erasure unit too hot</p>	<p>› Switch the unit off and allow it to cool.</p>
<p>Erasure unit fault</p>	<p>LED defective</p>	<p>› Contact technician.</p>

Problem	Probable cause	Solution
Imaging software fails to recognize the unit	Unit not switched on	› Switch the device on.
	Cable between unit and computer not correctly connected	› Check the connecting cable
	Computer does not detect any connection to the unit	› Check the connecting cable. › Check the network settings (IP address and subnet mask).
	Hardware error The IP address of the unit is being used by another unit	› Contact technician. › Check the network settings (IP address and subnet mask) and assign a unique IP address to each unit. › Inform a service technician if the problem persists.
The unit does not appear in the VistaConfig selection list	Unit is connected downstream of a router	› Configure the IP address without an intermediate router on the unit. › Reconnect the router. › Manually enter the IP address in VistaConfig and register the unit.
	The IP address of the unit is being used by another unit	› Check the network settings (IP address and subnet mask) and assign a unique IP address to each unit. › Inform a service technician if the problem persists.
The unit appears in the VistaConfig selection list, but no connection	Subnet masks of the computer and the unit do not match	› Check subnet masks, adjust if necessary.
Error message “E2490”	The connection to the unit was interrupted while the software was still attempting to communicate with the unit	› Restore the connection to the unit. › Repeat the process.
Error during data transmission between unit and computer. Error message “CRC error timeout”	Connecting cable used is incorrect or too long	› Only use original cables.
VistaSoft detected that the wrong side of the image plate may have been exposed.	The image plate was exposed on the back (inactive) side while the X-ray was being taken.	Check the orientation and the image quality before making a diagnosis. When diagnosing the X-ray image, note that the X-ray image is displayed mirror-inverted.

14.3 Fault on the unit.

Problem	Probable cause	Solution
Unit ejects the image plate without the image data being transmitted to the imaging software. Error message: "Incorrect image plate type inserted"	Image plates other than image plates IQ from Dürr Dental were used	<ul style="list-style-type: none"> › Use only image plates IQ made by Dürr Dental. › The image was saved to the unit. The image plate has been erased. › Transfer the image to the imaging software, see "11.4 Transmitting image data to the computer".
Unit does not switch on	No mains voltage	<ul style="list-style-type: none"> › Check the mains cable and plug connection and replace if necessary › Check the power supply unit. › If the touch screen does not light up, replace the power supply.
	On/Standby switch is defective	<ul style="list-style-type: none"> › Check the mains fuse in the building. › Contact technician.
Unit switches off after a short time	Mains cable or power supply unit plug not inserted correctly	<ul style="list-style-type: none"> › Check the mains cable and plug connections.
	Hardware defect	<ul style="list-style-type: none"> › Contact technician
	Mains supply voltage too low	<ul style="list-style-type: none"> › Check the mains supply voltage.
Loud noises lasting more than 30 secs after unit is turned on	Radiation deflector defective	<ul style="list-style-type: none"> › Contact technician
Unit not responding	The unit has not yet completed the startup procedure	<ul style="list-style-type: none"> › Wait 20 - 30 seconds for the startup procedure to be completed.
	Unit is blocked by the firewall	<ul style="list-style-type: none"> › Enable unit ports in the firewall settings.
Unit is on, touch screen does not display	Touch screen initialization fault Screen brightness set too dark Touch screen defective	<ul style="list-style-type: none"> › Switch the unit off and on again. › Update firmware › Increase touch screen brightness. › Contact technician
Image plate does not fit in input slot	Incorrect plate guide used	<ul style="list-style-type: none"> › Install corresponding plate guide for image plate size
Light protection cover slips	Wrong image plate input slot (too big) used	<ul style="list-style-type: none"> › Use the properly sized plate guide
Indicator for use does not light up	Insert is not used correctly	<ul style="list-style-type: none"> › Use insert correctly.
Computer and device not working properly	Network connection cable between device and computer not connected	<ul style="list-style-type: none"> › Check cable connection
	IP address of the device is used by another device	<ul style="list-style-type: none"> › Change network setting (IPAddress and subnet mask)
		<ul style="list-style-type: none"> › Assign a unique IP address to every device.

14.4 Error messages on the touch screen.

Problem	Probable cause	Solution
Error code 1008	Connection interrupted	<ul style="list-style-type: none"> › Update the firmware.
Error code 1010	Temperature of unit too high	<ul style="list-style-type: none"> › Allow the unit to cool down. › Contact technician.
Error code 1022	Subassembly not initialised	<ul style="list-style-type: none"> › Fault in software, update the software if required. › Contact technician.
Error code 1024	Internal data communication fault	<ul style="list-style-type: none"> › Switch the unit off and back on again. › Update the firmware. › Darken the room. › Turn the unit so that no light can fall directly into the insertion slot.
Error code 1026	Incorrect acquisition mode	<ul style="list-style-type: none"> › Select a different acquisition mode › Inform a service technician. › Update the firmware. › Reset the scanning modes to the factory settings via the unit interface or the Imaging Software.
Error code 1100	Permitted time for scan process exceeded	<ul style="list-style-type: none"> › Contact technician. › Check the belt drive. › Check for blockage, remove image plate from unit.
Error code 1104	Erasure unit fault	<ul style="list-style-type: none"> › Contact technician. › Replace the erasure unit.
Error code 1153	Unit fault	<ul style="list-style-type: none"> › Switch the unit off and on again. › Update firmware.
Error code 1154	Internal data communication fault	<ul style="list-style-type: none"> › Switch the unit off and on again. › Update firmware.
Error code 1160	Final pentaprism assembly rotation speed not reached	<ul style="list-style-type: none"> › Contact technician. › Update firmware. › Replace the pentaprism assembly if the problem occurs regularly.
Error code 1170	SOL sensor timeout. Fault on the laser, SOL sensor or pentaprism assembly	<ul style="list-style-type: none"> › Contact technician. › Update firmware.
Error code 1172	SOL sensor timeout. Fault on the laser, SOL sensor or pentaprism assembly	<ul style="list-style-type: none"> › Inform a service technician. › Update the firmware.

Problem	Probable cause	Solution
Error code 10000	Unit is exposed to too much light	<ul style="list-style-type: none"> › Darken the room. › Turn the unit so that no light is directly incident into the entry slot.
Error code 10009	Internal communication error warning; unit remains ready for operation	<ul style="list-style-type: none"> › Update the firmware.
Error code 10017	Unit shuts down	<ul style="list-style-type: none"> › Wait until the unit has shut down completely
Error code 10025	Incorrect or damaged image plate used	<ul style="list-style-type: none"> › Use an approved image plate or check the image plate for damage. The image plate has been erased.
Error code 10030	Incorrect or damaged image plate used	<ul style="list-style-type: none"> › Use an approved image plate or check the image plate for damage. › The image was saved to the unit. The image plate has been erased. › Transfer the image to the imaging software, see "1.4 Transmitting image data to the computer".
Error code 2	System error during startup of the unit	<ul style="list-style-type: none"> › Switch the unit off and back on again. › Update the firmware.
Error code 78	Memory card full	<ul style="list-style-type: none"> › Transmit image data to the computer. › Insert an empty memory card.
	Fault during memory cleanup	<ul style="list-style-type: none"> › Press and hold the reset button while switching on the unit. › Update firmware. › Press and hold the reset button while switching on the unit.
Firmware not running	Firmware update has been carried out	<ul style="list-style-type: none"> › Switch the unit off and on again.
	Internal communication fault	<ul style="list-style-type: none"> › Switch the unit off and on again.
Settings (e.g. language) reset after unit restart	Faulty configuration file	<ul style="list-style-type: none"> › Update the firmware. › Reset the configuration to the factory settings and reconfigure.
Warning message during shutdown of the unit	Not a malfunction	<ul style="list-style-type: none"> › Update the firmware.



15 Scanning times

The scanning time corresponds to the time taken for complete scanning of image data and depends on image plate format and pixel size.

The time to image will depend largely on the computer system used and its work load. Times stated are approximate.

Theoretical resolution (LP/mm)	40	25	20	10
Pixel size (µm)	12.5	20	25	50
Intra Size 0 (2 x 3)	26 s	16 s	13 s	6 s
Intra Size 1 (2 x 4)	32 s	20 s	16 s	8 s
Intra Size 2 (3 x 4)	32 s	20 s	16 s	8 s
Intra Size 3 (2.7 x 5.4)	40 s	25 s	20 s	10 s
Intra Size 4 (5.7 x 7.6)	53 s	33 s	27 s	14 s

16 File size (uncompressed)

The actual file size will depend on the image plate format and the pixel size. File sizes stated are approximate and have been rounded upwards.

Suitable compression methods can considerably reduce the file size without loss of data.

Theoretical resolution (LP/mm)	40	25	20	10
Pixel size (µm)	12.5	20	25	50
Intra Size 0 (2 x 3)	9.86 MB	3.85 MB	2.46 MB	0.62 MB
Intra Size 1 (2 x 4)	12.29 MB	4.80 MB	3.07 MB	0.77 MB
Intra Size 2 (3 x 4)	16.27 MB	6.36 MB	4.07 MB	1.02 MB
Intra Size 3 (2.7 x 5.4)	19.01 MB	7.43 MB	4.75 MB	1.19 MB
Intra Size 4 (5.7 x 7.6)	55.45 MB	21.66 MB	13.86 MB	3.47 MB

17 Electromagnetic Compatibility (EMC) Compliance Information

The following provides the EMC technical data used to show that each VistaScan Ultra View is designed and manufactured to meet the electromagnetic requirements of international standard IEC 60601-1-2 as shown below. The user should ensure that the VistaScan Ultra View unit is indeed used within this environment to ensure that the system will perform as intended.

- › Portable and mobile RF communications equipment can affect VistaScan Ultra View operation.
- › Use of accessories or cables other than those specified or provided by the manufacturer may result in increased VistaScan Ultra View emissions and decreased VistaScan Ultra View immunity.
- › The VistaScan Ultra View should not be used adjacent to or stacked with other equipment that may interfere with proper VistaScan Ultra View operation.

18 Manufacturer's Guidance and Declaration - Electromagnetic Emissions

The VistaScan Ultra View is intended to be used within the electromagnetic environment specified below. The user of the VistaScan Ultra View should ensure that it is used in such an environment.

Emissions test	Compliance	Electromagnetic Environment - Guidance
RF emissions CISPR 11	Group 1	VistaScan Ultra View uses radio-electric energy only for its internal subsystems. It therefore emits very low energy and is not likely to interfere with nearby electronic devices.
RF emissions CISPR 11	Class A	VistaScan Ultra View is suitable for use in all establishments other than domestic, and may also be used in domestic establishments and those directly connected to the public low voltage power supply network that supplies buildings used for domestic purposes provided the following warning is heeded:
Harmonic emissions EN 61000-3-2	Class A	Warning: This equipment is intended for use by health-care professionals only. This equipment may cause radio interference or may disrupt the operation of nearby equipment. It may be necessary to take mitigation measures, such as reorienting or relocating the VistaScan Ultra View or shielding the location.
Voltage fluctuations/flicker EN 61000-3-3	Complies	

Manufacturer's Guidance and Declaration - Electromagnetic Immunity

<p>VistaScan Ultra View is intended to be used within the electromagnetic environment specified below. The user of the VistaScan Ultra View should ensure that it is used in such an environment.</p>			
Immunity test	IEC 60601 Test level	Compliance level	Electromagnetic Environment - Guidance
Electrostatic discharge (ESD) IEC 61000-4-2	± 6kV contact ± 8kV air	± 6kV ± 8kV	Floors should be wood, concrete or ceramic tile. If floors are covered with synthetic material, the relative humidity should be at least 30%.
Electrical fast transient/burst IEC 61000-4-4	± 2 kV for power supply lines ± 1 kV for input/output lines	± 2kV ± 1kV	Mains power quality should be that of a typical commercial or hospital environment.
Surge IEC 61000-4-5	± 1 kV line(s) to line(s) ± 2 kV line(s) to earth	± 1kV N/A	Mains power quality should be that of a typical commercial or hospital environment.
Voltage dips, short interruptions and voltage variations on power supply input lines IEC 61000-4-11	<5% Ur (>95% dip in Ur) for 0.5 cycle 40% Ur (60% dip in Ur) for 5 cycles 70% Ur (30% dip in Ur) for 25 cycles <5% Ur (>95% dip in Ur) for 5 s	<5% Ur - 10ms 40% Ur - 100ms 70% Ur - 500ms <5% Ur - 5 s	Mains power quality should be that of a typical commercial or hospital environment. If the user of the VistaScan Ultra View requires continuous operation during power mains interruptions in the main power supply, it is recommended that the VistaScan Ultra View be powered from an uninterruptible power supply providing emergency power.
Power frequency (50/60Hz) Magnetic field IEC 61000-4-8	3 A/m	3 A/m	Power frequency magnetic fields should be at levels characteristic of a typical location within a typical commercial or hospital environment.

Note: Ur is the AC mains voltage prior to application of the test level.

Manufacturer's Guidance and Declaration – Electromagnetic Immunity

VistaScan Ultra View is intended to be used in the electromagnetic environment specified below. The user of the VistaScan Ultra View should ensure that it is used in such an environment.

Immunity test	IEC 60601 Level	Compliance level	Electromagnetic Environment - Guidance
			<p>Portable and mobile RF communication equipment should be used no closer to any part of the VistaScan Ultra View, including cables, than the recommended separation distance calculated from the equation applicable to the frequency of the transmitter.</p> <p>Recommended separation distance:</p>
Conducted RF IEC 61000-4-6	3 Vrms 150 kHz to 80 MHz	3 V	$d = 1.16 \sqrt{P}$
Radiated RF IEC 61000-4-3	3 V/m 80 MHz to 2.5 GHz	3 V/m	<p>$d = 1.16 \sqrt{P}$ 80 MHz to 800 MHz $d = 2.33 \sqrt{P}$ 800 MHz to 2.5 GHz</p> <p>where P is the maximum output power of the transmitter in Watts (W) according to the transmitter manufacturer and d is the recommended separation distance in metres (m).</p>
			<p>Field strengths a from fixed RF transmitters, as determined by an electromagnetic site survey, should be less than the compliance level in each frequency b.</p> <p>Interference can occur nearby devices bearing the following symbol:</p>

Note 1: At 800 MHz, the higher frequency range applies.

Note 2: These guidelines may not apply in all situations. Electromagnetic propagation is affected by absorption and reflection from structures, objects and people.

- a Field strengths from fixed transmitters, such as base stations for radio (cellular/cordless) telephone and land mobile radios, AM and FM radio broadcast, and TV broadcast can not be predicted theoretically with accuracy. To assess the electromagnetic environment due to fixed RF transmitters, an electromagnetic site survey should be considered. If the measured field strength in the location in which the VistaScan Ultra View is used exceeds the applicable RF compliance level above, the VistaScan Ultra View should be observed to verify normal operation. If abnormal performance is observed, additional measures may be necessary, such as re-orienting or relocating the VistaScan Ultra View.
- b Over the frequency range 150 kHz to 80 MHz, field strengths should be less than 3 V/m.

19 Recommended separation distances between equipment

Distance between portable and mobile RF communications equipment

VistaScan Ultra View is intended for use in an electromagnetic environment in which radiated RF interferences are controlled. The user of the VistaScan Ultra View unit can help prevent electromagnetic interference by maintaining a minimum distance between portable and mobile RF communications equipment (transmitters) and VistaScan Ultra View as recommended below, in accordance with the maximum output power of the communications equipment.

Maximum assigned output power of the transmitter W	Separation distance as a function of the transmitter's frequency m		
	150 kHz to 80 MHz	80 MHz to 800 MHz	800 MHz to 2.5 GHz
	$d = 1.16 \sqrt{P}$	$d = 1.16 \sqrt{P}$	$d = 2.33 \sqrt{P}$
0.01	0.116	0.116	0.233
0.1	0.366	0.366	0.736
1	1.16	1.16	2.33
10	3.66	3.66	7.36
100	11.6	11.6	23.3

For transmitters rated at a maximum output power not listed above, the recommended separation distance (d) in metres (m) can be established by using the equation applicable to the frequency of the transmitter, where P is the maximum output power rating of the transmitter in Watts (W) according to the transmitter manufacturer.

Note 1: At 80 and 800 MHz, the higher frequency range applies.

Note 2: These guidelines may not apply in all situations. Electromagnetic propagation is affected by absorption and reflection from structures, objects and people.

20 Handover record

This document confirms the qualified handover and provision of instructions for the medical device from Dürr Dental. This must be carried out by a qualified adviser for the medical device, who will instruct you in the proper handling and operation of the medical device.

EN

<u>Product name</u>	<u>Order number (REF)</u>	<u>Serial number (SN)</u>
_____	_____	_____
_____	_____	_____
_____	_____	_____
_____	_____	_____

- Visual inspection of the packaging for any damage
- Unpacking the medical device and checking for damage
- Confirmation of the completeness of the delivery
- Instruction in the proper handling and operation of the medical device based on the operating instructions

Notes:

Name of person receiving instruction:

Signature:

Name and address of the qualified adviser for the medical device:

Date of handover:

Signature of the qualified adviser for the medical device:



Manufactured for / Distributed by:

DÜRR DENTAL SE
Höpfungheimer Str. 17
74321 Bietigheim-Bissingen, Germany
Fon: +49 7142 705-0
www.duerrdental.com
info@duerrdental.com



Air Techniques, Inc.
1295 Walt Whitman Road
Melville, New York USA 11747- 3062
www.airtechniques.com



Medical Device Safety Service
Schiffgraben 41
30175 Hannover, Germany

Australian Sponsor: Emergo Australia
Level 20 Tower II, Darling Park
201 Sussex Street
Sydney, NSW 2000, Australia



MDSS CH GmbH
Laurenzenvorstadt 61
5000 Aarau, Switzerland

UK Responsible Person
MDSS-UK RP Limited
6 Wilmslow Road, Rusholme
Manchester M14 5TP
England, United Kingdom

